



Technology Solutions

TEK-BATCH 7900A

NEMA 4X Analog Input Batch Controller



INDICATOR/
CONTROLLER



www.tek-trol.com

Flow | Level | Temperature | Pressure | Valves | Analyzers | Accessories | TekValSys

Introduction

The Tek-Batch 7900A Analog Input Batch Controller

The Tek-Batch 7900A is an analog input (4-20 mA, 0-5 V, 1-5 V, etc.) digital batch controller specifically designed for single and multi-stage batching applications. It provides excellent but simple batch control capabilities with features such as preclose relays and automatic overrun correction for more accurate batches and convenient SafeTouch® through-glass buttons for simple operation and menu navigation without having to remove the cover. The preclose deactivates a specific relay before the batch is finished in order to allow slower fill rates and increased accuracy. Automatic overrun correction keeps the batch size accurate over time and with system wear. The Tek-Batch 7900A includes a 24 VDC power supply to drive the flowmeter and can be equipped with up to four internal relays and a 4-20 mA analog output.

Quick Overview

- Input: 0-20 mA, 4-20 mA; ± 10 VDC (0-5, 1-5, 0-10 V); Modbus PV (slave)
- Display: Dual-line 6-digit, 0.04ft (0.60") and 0.03ft (0.46")
- Enclosure: Smooth die-cast aluminum explosion-proof; NEMA 4X, 7, 9/IP68
- Power: 85-265 VAC or 12-24 VDC option
- Operating Temperature: -40 °F to 149°F (-40 °C to 65°C)

Operation

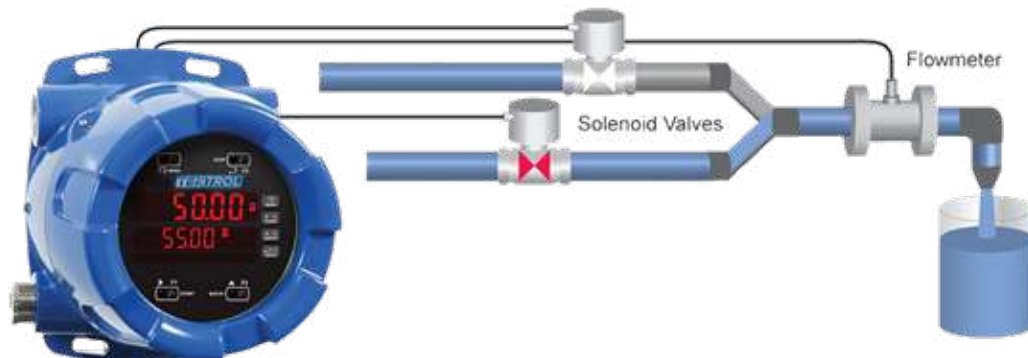
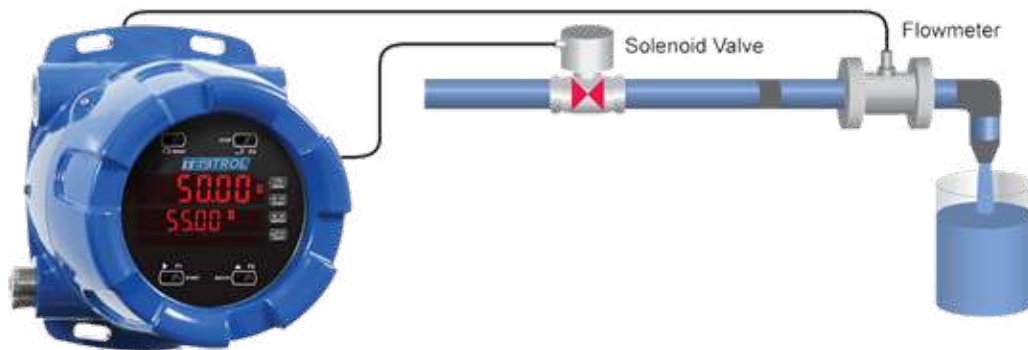

Features

- Sun Bright Display Standard
- Start, batch, & stop with pause front panel buttons
- Display batch total + rate, grand total, batch count or preset
- Single or multi-stage batching with up to 8 relays
- Automatic overflow correction
- Manual control or automatic batching
- SafeTouch® through-glass button programming
- Modbus RS-485 serial communications
- Flanges for wall or pipe mounting
- Isolated 24 VDC @ 25 mA transmitter power supply
- Grand total can count up or down
- On board USB and Meter View® Pro programming software

Application

- Batching
- Dosing
- Loading
- Blending

Dimensional Drawings

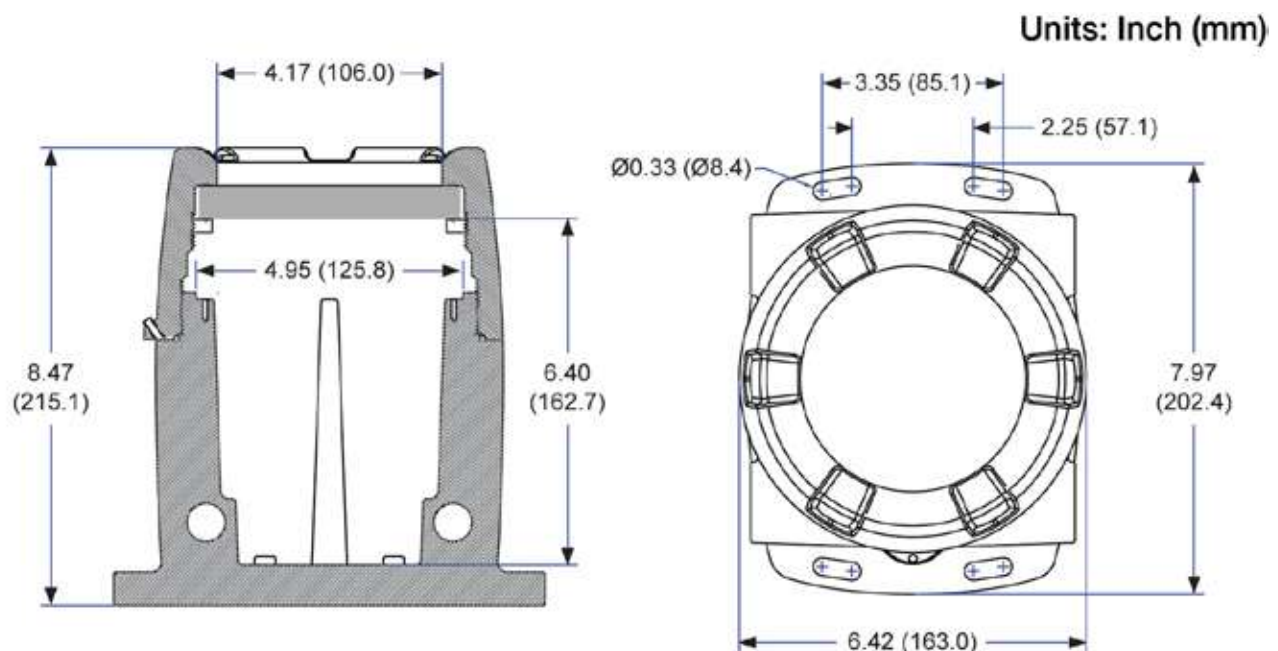



Specifications

General

| | |
|--|---|
| Display | Upper display: 0.04ft (0.60") high. Lower display: 0.03ft (0.46") high. Both are 6 digits (-99999 to 999999), red LEDs. |
| Default Display Assignment | The upper display shows batch total. The lower display shows rate with alternating units, and can be switched to show grand total, batch count, or preset with the STOP key. |
| Custom Display Assignment | The upper and lower displays may be assigned to rate, total, grand total, batch count, preset, set points, units (lower display only), alternating R & T, R & GT, preset & rate, max & min, or a Modbus display register. Any rate/total/grand total display may be programmed to alternate with a custom unit or tag. |
| Alternating Display | Displays alternate every 10 seconds when display is selected or the batch is paused. |
| Display Intensity | Eight user selectable intensity levels |
| Display Update Rate | 5/second (200 ms) |
| Over Range | Display flashes 999999 |
| Under Range | Display flashes -99999 |
| Front Panel | NEMA 4X, IP65 |
| Operating Methods | Three programmable front panel buttons (default START, BATCH, STOP), digital inputs, PC and MeterView Pro software, and Modbus registers. |
| Programming Methods | Four SafeTouch through-glass buttons when cover is installed. Four internal pushbuttons when cover is removed. |
| F4 Digital Input Contacts | 3.3 VDC on contact. Connect normally open contacts across F4 to COM. |
| F4 Digital Input Logic Levels | Logic High: 3 to 5 VDC Logic Low: 0 to 1.25 VDC |
| Noise Filter | Programmable from 2 to 199 (0 will disable filter) |
| Filter Bypass | Programmable from 0.1 to 99.9% of calibrated span. |
| Recalibration | Recommended at least every 12 months. |
| Max/Min Display | Max (Peak) / min (Valley) readings reached by the process are stored until reset by the user or until power is cycled. |
| Password | Three programmable passwords restrict modification of programmed settings and two prevent resetting the totals. |
| Non-Volatile Memory | All programmed settings are stored in non-volatile memory for a minimum of ten years if power is lost. |
| Power Options | 85-265 VAC 50/60 Hz, 90-265 VDC, 20 W max, or optional model with 12-24 VDC \pm 10%, 15 W max. |
| Fuse | Required external fuse: UL Recognized, 5 A max, slow blow; up to 6 controllers may share one 5 A fuse. |
| Isolated Transmitter Power Supply | Terminals P+ & P-: 24 VDC \pm 10%. internally selectable jumper for 24, 10, or 5 VDC supply. All models transmitter supply rated @ 25mA max. |
| Normal Rejection Mode | Greater than 60 dB at 50/60 Hz (PD8-6210) Isolation: 4 kV input/output-to-power line. 500 V input-to-output or output-to-P+ supply. |
| Over Voltage Category | Installation Overvoltage Category II: Local level with smaller transient over voltages than Installation Over voltage Category III. |
| Environmental | T6 Class operating temperature range Ta = -40 to 140°F T5 Class operating temperature range Ta = -40 to 140°F |
| Max Power Dissipation | Maximum power dissipation limited to 15.1 W. See PD8-6210/6310 instruction manual for additional details. |
| Connections | Removable screw terminal blocks accept 12 to 22 AWG wire, RJ45 for external relays, digital I/O, and serial communication adapters. |
| Enclosure | Explosion-proof die cast aluminum with glass window, corrosion resistant epoxy coating, color: blue. NEMA 4X, 7, & 9, IP68. Default conduit connections: Four $\frac{3}{4}$ " NPT threaded conduit openings and two $\frac{3}{4}$ " NPT metal conduit plugs with 0.03ft hex key fitting installed. Additional conduit opening configurations may be available; verify quantity and sizes on specific device labeling during installation. |
| Mounting | Four slotted flanges for wall mounting or NPS 1 $\frac{1}{2}$ " to 2 $\frac{1}{2}$ " or DN 0.13 to 0.21ft pipe mounting |
| Weight | 16.0 lbs (7.26 kg) |
| Dimensions | 6.42" x 7.97" x 8.47" (W x H x D) (0.53ft x 0.66ft x 0.70ft) |
| USB Connection | Compatibility: USB 2.0 Standard, Compliant Connector Type: Micro-B receptacle Cable: USB A Male to Micro-B Cable Driver: Windows 98/SE, ME, 2000, Server 2003/2008, XP 32/64-Bit, Vista 32/64-Bit, Windows 7 32/64-Bit, Windows 10 32/64-Bit Power: USB Port |

Analog Input

| | |
|----------------------------------|--|
| Inputs | Field selectable: 0-20, 4-20 mA, ± 10 VDC (0-5, 1-5, 0-10 V), Modbus PV (Slave) |
| Accuracy | $\pm 0.03\%$ of calibrated span ± 1 count, square root & programmable exponent accuracy range: 10-100% of calibrated span |
| Temperature Drift | 0.005% of calibrated span/ $^{\circ}$ F max from 0 to 149 $^{\circ}$ F ambient, 0.01% of calibrated span/ $^{\circ}$ F max from -40 to 32 $^{\circ}$ F ambient |
| Signal Input Conditioning | Linear, square root, programmable exponent, or round horizontal tank volume calculation. |
| Multi-Point Linearization | 2 to 32 points |
| Programmable Exponent | 1.0001 to 2.9999 |
| Low-Flow Cutoff | 0-999999 (0 disables cutoff function) |
| Calibration Range | Input Range: Minimum Span Input 1 & 2 4-20 mA, 0.15 mA ± 10 V, 0.10 V (An error message will appear if input 1 and input 2 signals are too close together.) |
| Input Impedance | Voltage ranges: greater than 1 M Ω . Current ranges: 50 - 100 Ω (depending on resettable fuse impedance). |
| Input Overload | Current input protected by resettable fuse, 30 VDC max. Fuse resets automatically after fault is removed. |
| HART Transparency | Analog input will not interfere with existing HART communications on the wired 4-20 mA signal |

Batch Controller

| | |
|--|---|
| Rate Display Indication | 0 to 999999, lead zero blanking. "R" LED illuminates while displaying rate. |
| Total Displays & Grand Total Overflow | 0 to 999,999; automatic lead zero blanking. "T" LED is illuminated while displaying batch total and "GT" for grand total. Up to 999,999,999 with total-overflow feature. "oF" is displayed to the left of grand total overflow and LED is illuminated. |
| Batch Total Decimal Point | Up to five decimal places or none: 0.00000, 00.0000, 000.000, 0000.00, 00000.0, or 000000. (Total decimal point is independent of rate decimal point.) |
| Totalizer | Calculates total based on rate and field programmable multiplier to display total in engineering units. Time base must be selected according to the time units in which the rate is displayed. |
| Total Conversion Factor | 0.00001 to 999,999 |
| Batch Preset | 0.00001 to 999,999 based on batch total decimal point. |
| Automatic Batch Restart Delay | 00000.1 to 999.9 seconds. The batch will automatically restart after completion of the last batch. |
| Grand Total Rollover | Totalizer rolls over when display exceeds 999,999,999. Relay status reflects the display value. |
| Grand Total Alarms | Up to seven, user selectable under Setup menu. Any set point can be assigned to grand total and may be programmed anywhere in the range of the controller for grand total alarm indication. Note that Relay 1 should always be assigned to batch control (total). |
| Grand Total Reset | Via front panel button, external contact closure on digital inputs, automatically via user selectable preset value and time delay, or through serial communications. |
| Grand Total Reset Password | A grand total password may be entered to prevent resetting the grand total from the front panel. |
| Non-Resettable Grand Total | The grand total can be programmed as a non-resettable total by entering the password "050873". |

Relays

| | |
|---------------------------------|--|
| Rating | 2 or 4 SPDT (Form C) internal and/or 4 SPST (Form A) external; rated 3 A @ 30 VDC and 125/250 VAC resistive load; 1/14 HP (≈ 50 W) @ 125/250 VAC for inductive loads |
| Noise Suppression | Noise suppression is recommended for each relay contact switching inductive loads. |
| Relay Assignment | Relays may be assigned to batch control, sampling, rate, or grand total alarms. |
| Preclose | 0-100% of batch size, individually user programmable for each additional batch control relay beyond the first. |
| Alarm Dead Band | 0-100% of span, user programmable |
| High or Low Alarm | User may program any alarm for high or low trip point. Unused alarm LEDs and relays may be disabled (turned off). |
| Batching Relay Operation | Single or (2 to 8) multi-relay batching with optional preclose for multi-stage operation. Each additional relay may be programmed with an individual preclose value. |
| Alarm Relay Operation | Automatic (non-latching), latching (requires manual acknowledge), sampling (based on rate or grand total), pump alternation control (2 to 8 relays), off (disable unused relays), and manual on/off control mode. Alarms are active only when the batch is running. |
| Alarm Relay Reset | User selectable via front buttons, digital inputs, or PC 1. Automatic reset only (non-latching), when input passes the reset point or total is reset to zero. 2. Manual reset only, when batch is stopped (latching). 3. Manual reset only after alarm condition has cleared (latching) |

| | |
|---------------------|--|
| Time Delay | 0 to 999.9 seconds, on & off relay time delays. Programmable and independent for each relay. |
| Fail-Safe Operation | Programmable and independent for each relay. |
| Auto Initialization | When power is applied, relays will reflect the state of the input. Alarms are active only when the batch is running. |

Installation

System Setup

- Both valves are closed with an empty barrel in place. The batched total is displayed in the upper display, the preset is selected for the lower display.

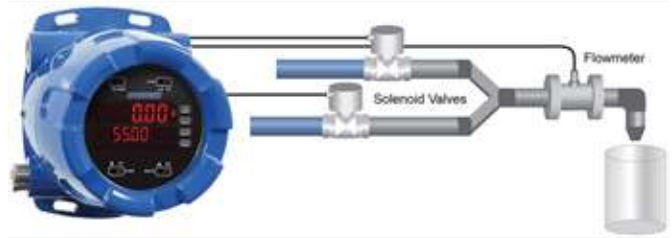

Batch Start

- The START button is pressed, with both valves open. The barrel begins to fill.

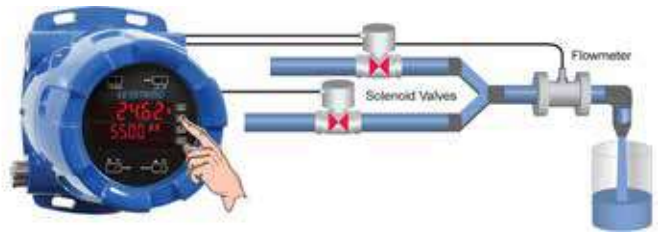

Preclose Valve

- When the batch total reaches a value of 50.00 (Preset [55.00] Preclose [5.00]) the full-flow valve closes. The fill rate of the tank slows as a result.

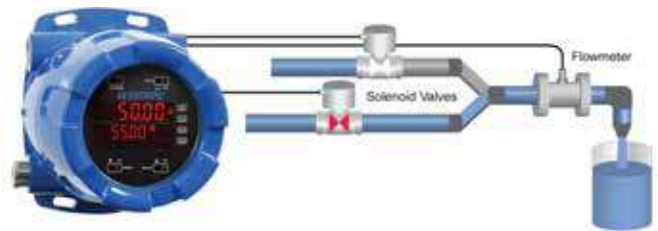

Completed Batch

- When the batch total equals the preset amount, the restricted-flow valve closes. The barrel is now full. If some overrun occurs, the next batch will adjust for this offset amount to maintain accuracy.

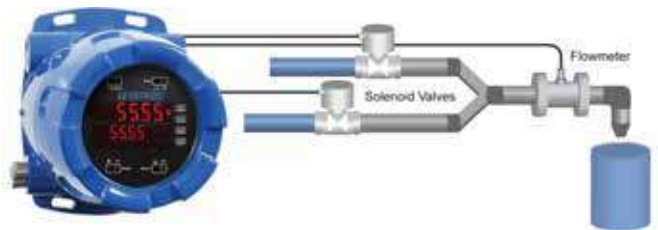

Change Preset

- After placing a new, empty barrel, a new preset fill amount may be selected with the Batch key, while the process is stopped.

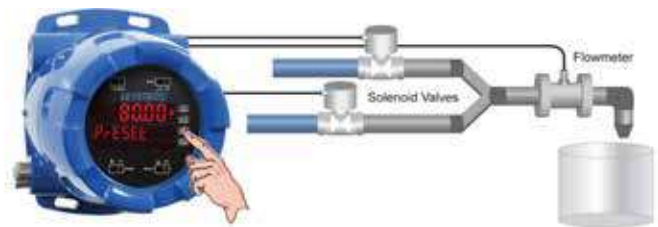

Begin New Batch

- Press the START key and a new batch will begin. With both valves open, the process continues.

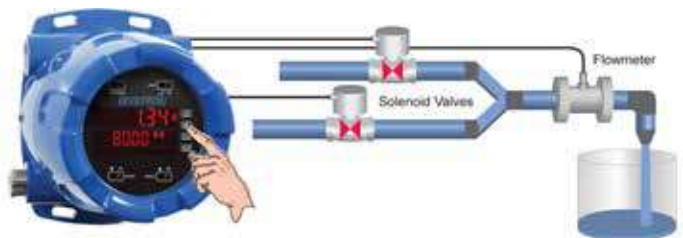

Pause/Stop

- At any time, the STOP button may be pressed, once to Pause the process, or twice to cancel the batch, which stops the process.

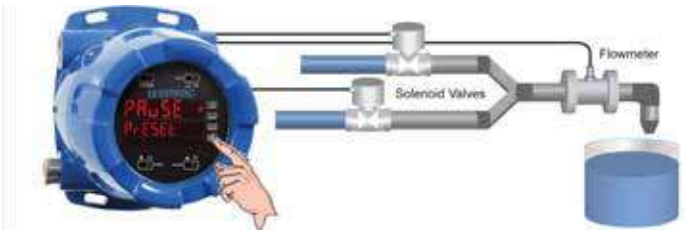

Popular Models

| Model Number | Description |
|--------------|---|
| 7900A-6H2 | Analog Input Batch Controller |
| 7900A-6H5 | Analog Input Batch Controller with 4-20mA Accessories |

Accessories

| Model Number | Description |
|--------------|---|
| 7800A-6846 | Steel Pipe Mounting Kit |
| 7800A-6846SS | Stainless Steel Pipe Mounting Kit |
| 7800B-002 | 3/4" M-NPT to 1/2" F-NPT Approved Reducer |

Customer Service and Support



TEKMATION LLC reserves the right to change the designs and/or materials of its products without notice. The contents of this publication are the property of TEKMATON and cannot be reproduced by any other party without written permission. All rights reserved. Copyright © 2016 TEKMATON LLC
DOC # TEK/AK/180910/TEK-BATCH/A
TEKMATION LLC



www.tek-trol.com

Tek-Trol is a fully owned subsidiary of TEKMATON LLC. We offer our customers a comprehensive range of products and solutions for process, power, and oil and gas industries. Tek-Trol provides process measurement and control products for Flow, Level, Temperature and Pressure Measurement, Control Valves and Analyzer systems. We are present in 15 locations globally and are known for our knowledge, innovative solutions, reliable products, and global presence.

Tek-Trol LLC

796 Tek Drive Crystal Lake, IL 60014 USA
Tel: +1 847 857 6076, +1 847 655 7428 Fax: +1 847 655 6147
Email: tektrol@tek-trol.com
www.tek-trol.com